



Gobius 1, ¾ Level Alarm for Waste Holding Tanks, new version 5.0

Installation Guide

Before you begin

1. Please make sure that no part is missing. 1 sensor, 1 panel, 1 control unit, 1 3M cleaning towel, 1 Velcro fastening for the control unit, cables, 1 extra sensor tape (3M VHB 4932), warranty statement and installation instruction on how to attach the sensor.
2. Determine the best place on your tank to place the sensor and where to place the panel.
3. Determine the best way to safely access electricity from your battery 12/24 Volts.

Quick installation

- Attach the sensor to the tank
- Connect all parts
- Start Gobius
- Calibrate
- Test Gobius
- Ready

Attaching the sensors to the tank

Start by reading through the [green](#) document before attaching the sensor to the tank wall. Please visit www.gobius.se for latest news. There is also Tank Calculator for making it easier for you to calculate the right level to put the sensor on the tank wall.

Connect all parts

1. Decide where to place the Gobius panel. It can for instance be installed in your head/shower or near your waste holding tank. You may increase the length of the panel cable up to 50 m with a standard PC network Cat 5 cable.
2. We suggest that you make a small rectangle hole where you want to place the cable from the panel to the control unit. The hole should be at least 4 mm x 22 mm. Please see the enclosed hole template at page 5.
3. Use the pre-attached 3M adhesive to fasten the panel to the wall.
4. Connect the panel and the sensor to the control unit. Then connect the cable to the battery. Make sure to connect + and – correctly to the battery (+ is white/grey marked and – is black),



as also described on the control unit. Please see the illustration at page 5.

5. If you want to connect Gobius to an external display from VDO, Wema, Faria or others, you should use the analogue output on the control unit together with the enclosed black cable.

Start Gobius

Connect power source cable to the control unit. Then as Gobius is starting all lamps are lit, one after another, once. Finally the **red, yellow** and **green** lamps will light saying that you have connected all parts correct. Now you only have to do the calibration.

Calibrate always with empty tank

No tanks are the same; there are always differences in e.g. material, size, thickness, construction and age. In order to compensate for these differences you have to calibrate the system before you can start to use your Gobius. To start the calibration, start by making sure that your tank is completely empty. During the measuring you may hear a soft humming sound from the sensor.

Calibration during installation

1. Start by draining the tank
2. Start Gobius and wait for the red, yellow and green lights
3. Press and hold the  button until all 4 lights are on
4. Release the button as soon as the lights are on
5. The calibration starts automatically
6. When the blue light is on the calibration is done

Calibration at a later date

1. Start by draining the tank
2. When Gobius is on, press the  button and hold
3. Wait until all 4 lights are on
4. Once the lights are on, release the button
5. The calibration starts automatically
6. When the blue light is on the calibration is done

Test Gobius

If possible, please finalize the installation by refilling the tank with liquid to verify that Gobius works according to your requirements.

2 different ways of turning Gobius on and off

You start Gobius by a quick push on the panel's  button or by



switching on the power from an external source. A function control on lamps and sensors is immediately performed. When the control is done the level is measured and the correct lamp is lit.

You turn off Gobius by a quick push on the  button or by switching off the current from an external source. When Gobius is turned off it will memorize all settings and the calibration. I.e. you will not need to redo the calibration due to the power being turned off for a lengthy period of time.

Error

If there should be a problem with the sensor, either with the connection or with the sensor itself, this is illustrated by the responding lamp (red) on the panel showing a flashing light together with the blue lamp.

For further information, please see the “table of lights” at pages 6 and 7.

You must act on this before you can use Gobius.

If you suspect that the system does not function correctly, please contact our support service by email, support@jmmarin.se or by phone. This support service is free of charge for products that are registered on our web-site, www.gobius.se.

Change of default settings

You will find the default settings of Gobius on page 6 of this documentation. You change the settings by pressing and holding the  button on the panel. Gobius automatically flicks through the alternatives as presented in the table on page 6. Release the button when your choice is shown. Thereby you have made a new setting. Repeat this until you have made the changes you want.

1. Leave Gobius on
2. With a pen, make notes in the table of the changes you need to do
3. Press and hold the  button until the chosen rows' colours are shown in the panel
4. Release the button to make your choice a setting
5. Repeat this until you have made the changes you want

By keeping the  button pressed until all alternatives are passed, you may flick through all alternatives without making any change of settings. A wrongly chosen setting is corrected by repeating the procedure and thus correcting the setting.

Settings control

Each and every time you turn off Gobius using the  button, your settings are presented by colour combinations on the panel according to the table on page 6. This will not happen when you turn off Gobius from an external source.



Analogue instrument

It is possible to plug in an analogue instrument to show the tank level. In the table on page 6 you will find four alternatives to choose between. On page 8 you will find an illustration showing how to plug in the instrument to Gobius' control unit. The extra black cable is intended for this purpose. We assume that you have an instrument with cables already installed in your vessel and that you wish to use this with Gobius.

Extra lamp/buzzer

In addition to the Gobius panel you may want to plug in a lamp or buzzer to give a warning when the tank is $\frac{3}{4}$ full. The illustration on page 8 shows how to plug in this additional surveillance.

Tips

We recommend that you put a layer of Vaseline, which prevents oxidation, on the plugs that are connected to the control unit. The electronics of the product are protected from damp. The sensor and the control unit do not resist water. Please contact FM Marin for advice on how to make Gobius waterproof. Furthermore, we recommend that you connect your Gobius via a 500 mA fuse.

The sensor is set to detect liquid levels through tank walls that are of different materials and thicknesses. If the tank's wall thickness is changing over time (e.g. due to possible contamination), you may need to redo the calibration according to the above instructions.

Gobius Sensor Technology (patented)

The sensor consists of two active parts; a shaker and an accelerator. When the shaker creates a vibration in the tank wall, the accelerator measures the size of the vibration and passes the data on to the control unit. The control unit then starts to calculate in order to give an exact estimate of whether the liquid level has passed the sensor or not.

Gobius requires no extra maintenance

The construction of Gobies has many advantages. For instance, since the sensor is never in direct contact with liquid inside the tank, it will not become worn out. Another positive aspect of Gobius is its low electricity consumption, which is less than 40 mA (12 Volts). Gobius does not require any extra maintenance.

For all these tank materials and tank wall thickness

- Stainless steel, steel, 1 - 3 mm
- Aluminium, 2 – 5 mm
- Polyethylene, 4 – 12 mm
- Fibre Glass, 4 – 8 mm



System Illustration

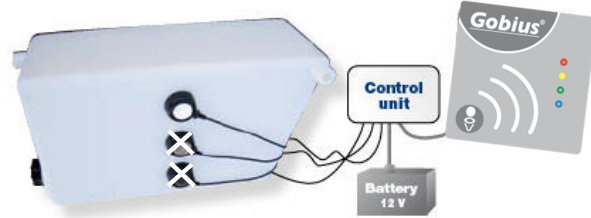
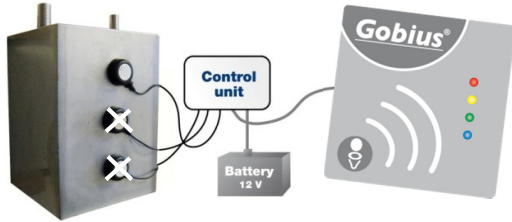

Plug from control unit to the panel

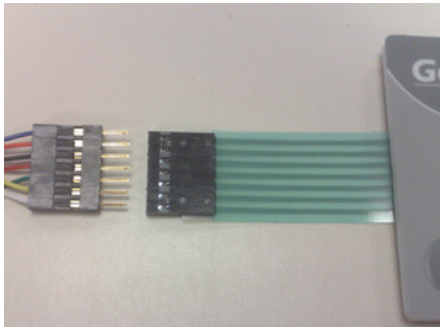

(If you connect the panel cable wrong way the red lamp on the panel will constantly light. It will not damage the product.)

Attaching the sensor to the tank

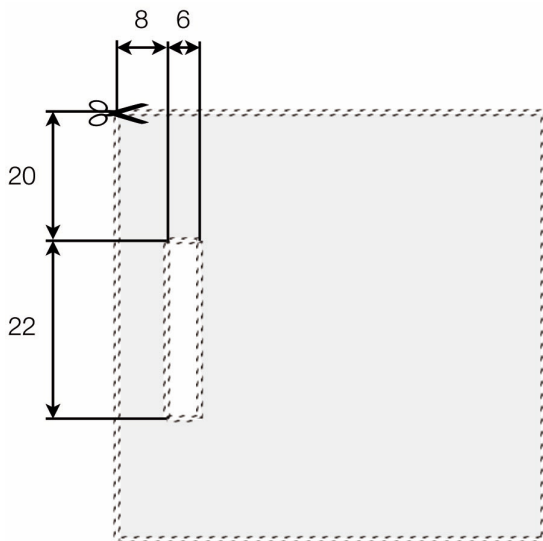
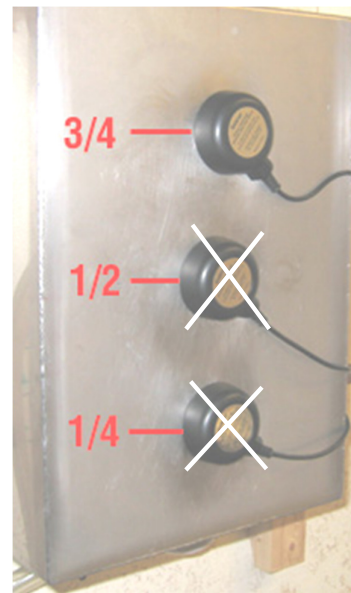

Hole template for the panel [mm]



Indicators in Setup Mode

Mark your choice	Lamp Red	Lamp Yellow	Lamp Green	Lamp Blue	Duration in seconds	Description
	●	●	●	●	5 s	Calibration
	○	●	○	○	5 s	Measurement period 1 minute
D	○	●	○	●	5 s	Measurement period 5 minutes
	○	●	●	○	5 s	Measurement period 10 minutes
	○	●	●	●	5 s	Measurement period 10 seconds (installation mode)
	●	○	○	○	5 s	Measurement period 8 hours
	●	●	○	○	5 s	Gauge, 4 - 20 mA, Industrial Std
D	●	●	○	●	5 s	Gauge, 10 - 190 Ω , European Std
	●	●	●	○	5 s	Gauge, 240 - 33 Ω , US Std
	●	●	●	●	5 s	Gauge, 0 – 5 Volt DC
	●	○	●	○	5 s	System Reset to default setting
	○	●	○	●	5 s	System Reset Acknowledge
	○	○	○	○	N/A	The setup mode will be exited without changing any parameters.

D = Default setting ● = light ○ = no light You change the settings by pressing and holding the  button on the panel. Gobius automatically flicks through the alternatives as presented in the table above. Release the button when your choice is shown. Thereby you have made a new setting. Repeat this until you have made the changes you want.



Table of lights – what the lamps on the panel show

Lamp Red	Lamp Yellow	Lamp Green	Lamp Blue	Explanation
●	●	●	○	At delivery Gobius is not yet calibrated
⊙	○	○	⊙	Test of the ¾-sensor
○	○	○	⊙	When measuring Tank level is not ¾
○	○	○	●	After measuring Tank is not over ¾
●	○	○	○	Tank level is over ¾
●⊙	○	○	●	Sensor error ¾-sensor not functioning
⊙	⊙	⊙	○	When calibrating Gobius is calibrating

● = light ○ = no light ⊙ = flashing light

Panel Flashing Codes

Permanent on	The sensor is not connected, or may be faulty
Fast flashing	Illogical result when all 3 sensors are taken together (Gobius 4)
Slow flashing	The sensor may not be properly mounted



Output current/resistance to gauge

Level	Industrial standard 4-20 mA current loop	European standard 10 - 190 Ω	US standard 240 – 33 Ω	Voltage output, 0-5 Volt, 10 kΩ min. load resistance
Below	6 mA ± 10%	25 Ω ± 5%	214 Ω ± 5%	1 V ± 5%
Above	18 mA ± 10%	190 Ω ± 5%	40 Ω ± 5%	4 V ± 5%

Electrical specification

Supply Voltage:	10 ~ 29 V DC
Supply Current:	200 mA max. (Operating), 50 mA max. (Idle)
Lamp driver outputs:	29 V DC max, 200 mA max
Analogue Instrument outputs:	4-20 mA current loop, 10-190 Ω, 240-33 Ω, 0-5 Volt DC
Max. voltage:	29V DC

External interfaces

